

Livestock Smart Scale

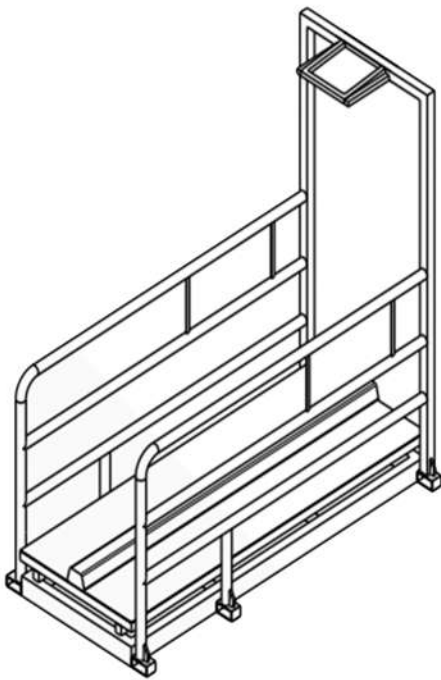

Technical Data

Standard dimensions

 Long: 2m
 High: 2m
 Width: 0.9m
 Tailored

Durability

 Robust and safe
 Corrosion resistant
 Stainless steel cells

Power supply

 Single phase 220v
 AC | DC

Operating system (O.S)

 iOS & Android
 PC web/app

Connectivity

 GSM Multi-operator
 WiFi*









Data analysis

 Continuous data analysis
 Adaptation with third parties
 platforms

Ear tags

 Passive UHF RFID tag

Features

-  **Fattening control**
-  **More equitable lots**
-  **Unprofitable animals detection**
-  **Comprehensive control**
-  **Profitability improvement**
-  **Anomaly detection**
-  **Automatic notifications**
-  **Easy drive**

Alerts

-  **Abnormal growth**
-  **Unprofitable growth**
-  **Target weight**
-  **Abnormal intake**

Check more information at:

www.digitanimal.com
info@digitanimal.com
 +34 914 126 657